



REFRIGERATION AND
AIR CONDITIONING

INSTRUCTIONS

EKC 202A (115 V)

EKC 202B (115 V)

EKC 202C (115 V)



084R9976



R18KL45J

084R9976

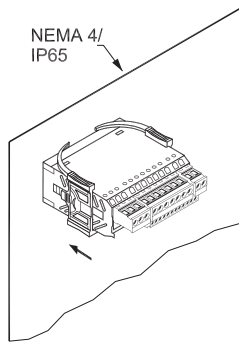
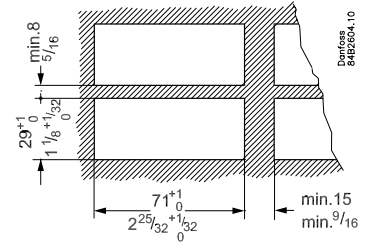
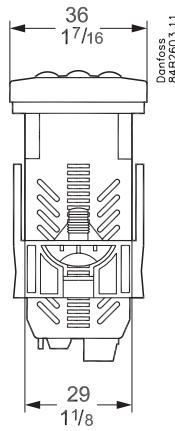
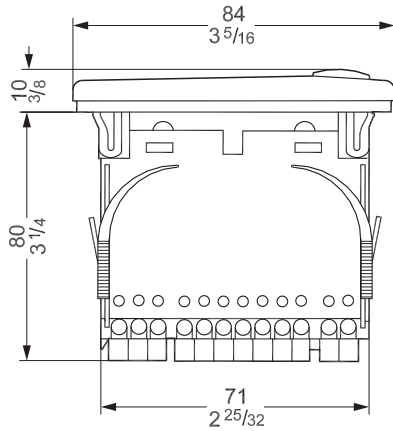

084R9976

$t_{amb} = 0 - +55^{\circ}\text{C}$

115 V a.c.

50/60 Hz

2.0 VA

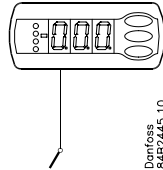

Danfoss
84B245.10

Type: Pt 1000 (1000 Ω / 0°C) /
Ptc 1000 (1000 Ω / 25°C) /
NTC-M2020 (5000 Ω / 25°C)

($\phi 06$)

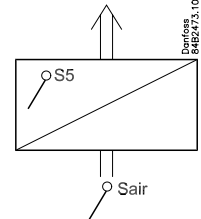

Danfoss
84B245.10

10 V < U < 256 V

| | CE (250 V a.c.) | UL *** (240 V a.c.) |
|-------------------------------------|--------------------------|---|
| DO1. Refrigeration * | 10 (6) A | 10 A Resistive 5FLA, 30LRA |
| DO2. Defrost * | 10 (6) A | 10 A Resistive 5FLA, 30LRA |
| DO3. Fan * | 6 (3) A | 6 A Resistive 3FLA, 18LRA 131 VA Pilot duty |
| DO4. Alarm, light or rail heat * | 4 (1) A Min. 100 mA** | 4 A Resistive 131 VA Pilot duty |

* DO1 and DO2 are 16 A relays. DO3 and DO4 are 8 A relays. Max. load must be kept.
** Gold plating ensures make function with small contact loads
*** UL-approval based on 30000 couplings

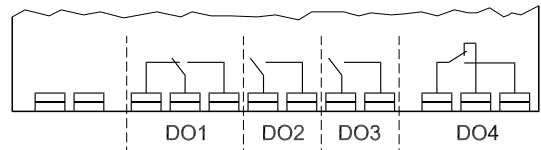

Danfoss
84B245.10

Data communication LON RS 485 / MOD-bus:

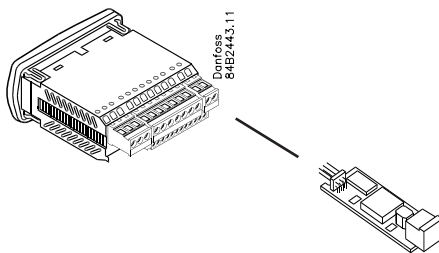

Danfoss
84B2443.11

LON

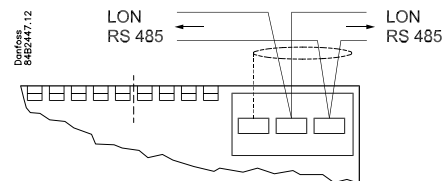

MOD-bus

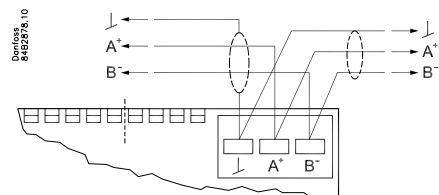

Danfoss
84B245.10

EKC 202A

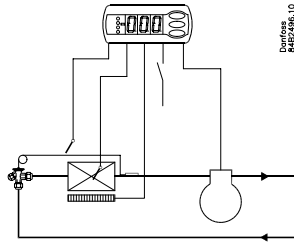

Danfoss
84B200.10

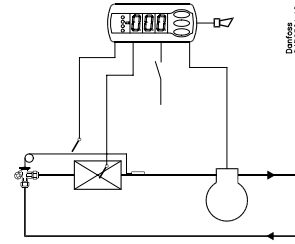

Danfoss
84B200.10

*) AU:
Gold, Or, Oro
 $\ell = \text{max. } 15 \text{ m}$

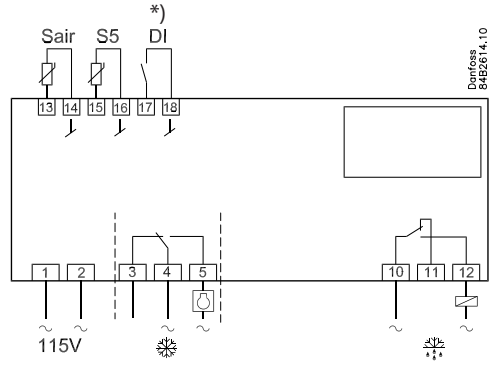

Danfoss
84B201.10

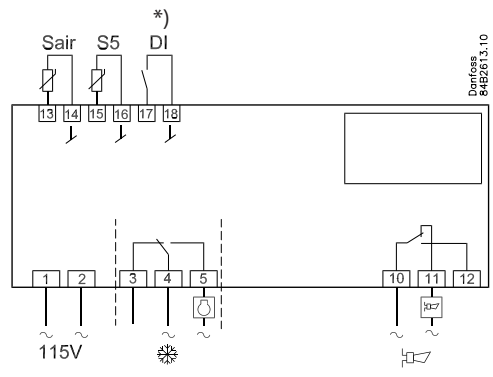

Danfoss
84B201.10

EKC 202B

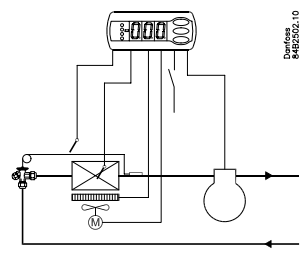

Danfoss
84B202.10

*) AU:
Gold, Or, Oro
 $\ell = \text{max. } 15 \text{ m}$

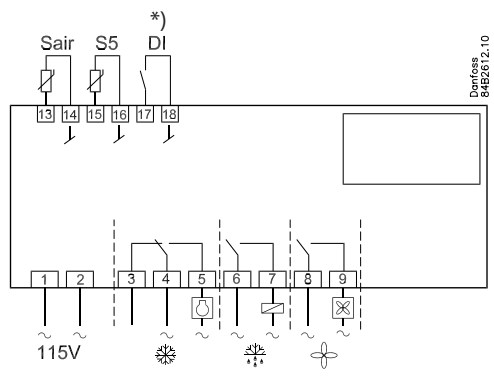

Danfoss
84B202.10

EKC 202C

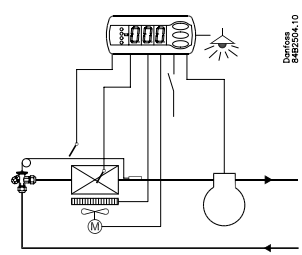

Danfoss
84B204.10

*) AU:
Gold, Or, Oro
 $\ell = \text{max. } 15 \text{ m}$

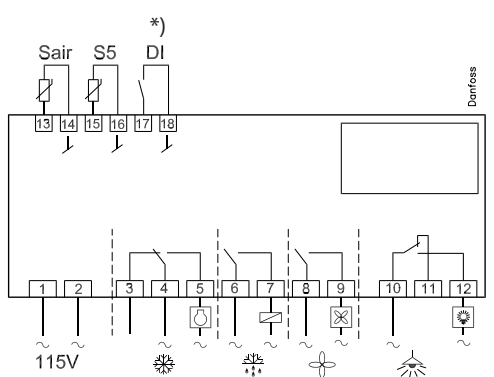

Danfoss

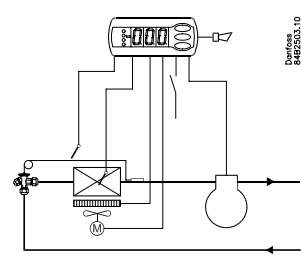

Danfoss
84B204.10

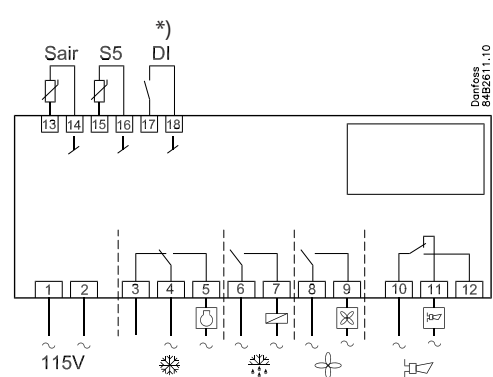

Danfoss
84B204.10

English

The buttons

Set menu

1. Push the upper button until a parameter is shown
2. Push the upper or the lower button and find that parameter you want to change
3. Push the middle button until the parameter value is shown
4. Push the upper or the lower button and select the new value
5. Push the middle button again to enter the value.

Set temperature

1. Push the middle button until the temperature value is shown
2. Push the upper or the lower button and select the new value
3. Push the middle button to select the setting.

Reading the temperature at sensor S5

- Push briefly the lower button

Manual start or stop of a defrost

- Push the lower button for four seconds.

Light emitting diode

 = refrigeration

 = defrost

 = fan running

Flashes fast at alarm

Cutout alarm relay / see alarm code

- Push briefly the upper button

Start-up:

Regulation starts when the voltage is on.

- 1 Go through the survey of factory settings. Make any necessary changes in the respective parameters.
- 2 For network. Set the address in o03 and then transmit it to the gateway/system unit with setting o04.

SW = 1.3x

| Function | Parameters | Codes | Controller | | | Min.-value | Max.-value | Factory setting | Actual setting |
|---|------------|---------|------------|----------|----------|------------|------------|-----------------|----------------|
| | | | EKC 202A | EKC 202B | EKC 202C | | | | |
| Normal operation | | | | | | | | | |
| Temperature (set point) | | --- | | | | -50°C | 50°C | 2°C | |
| Thermostat | | | | | | | | | |
| Differential | | r01 | | | | 0,1 K | 20 K | 2 K | |
| Max. limitation of setpoint setting | | r02 | | | | -49°C | 50°C | 50°C | |
| Min. limitation of setpoint setting | | r03 | | | | -50°C | 49°C | -50°C | |
| Adjustment of temperature indication | | r04 | | | | -20 K | 20 K | 0.0 K | |
| Temperature unit (°C/°F) | | r05 | | | | °C | °F | °C | |
| Correction of the signal from Sair | | r09 | | | | -10 K | 10 K | 0 K | |
| Manual service(-1), stop regulation(0), start regulation (1) | | r12 | | | | -1 | 1 | 1 | |
| Displacement of reference during night operation | | r13 | | | | -10 K | 10 K | 0 K | |
| Activation of reference displacement r40 | | r39 | | | | OFF | on | OFF | |
| Value of reference displacement (can be activated by r39 or DI) | | r40 | | | | -50 K | 50 K | 0 K | |
| Alarm | | | | | | | | | |
| Delay for temperature alarm | | A03 | | | | 0 min | 240 min | 30 min | |
| Delay for door alarm | | A04 | | | | 0 min | 240 min | 60 min | |
| Delay for temperature alarm after defrost | | A12 | | | | 0 min | 240 min | 90 min | |
| High alarm limit | | A13 | | | | -50°C | 50°C | 8°C | |
| Low alarm limit | | A14 | | | | -50°C | 50°C | -30°C | |
| Alarm delay DI1 | | A27 | | | | 0 min | 240 min | 30 min | |
| High alarm limit for condenser temperature (o70) | | A37 | | | | 0°C | 99°C | 50°C | |
| Compressor | | | | | | | | | |
| Min. ON-time | | c01 | | | | 0 min | 30 min | 0 min | |
| Min. OFF-time | | c02 | | | | 0 min | 30 min | 0 min | |
| Compressor relay must cutin and out inversely (NC-function) | | c30 | | | | 0 / OFF | 1 / on | 0 / OFF | |
| Defrost | | | | | | | | | |
| Defrost method (none/EL/gas) | | d01 | | | | no | gas | EL | |
| Defrost stop temperature | | d02 | | | | 0°C | 25°C | 6°C | |
| Interval between defrost starts | | d03 | | | | 0 hours | 48 hours | 8 hours | |
| Max. defrost duration | | d04 | | | | 0 min | 180 min | 45 min | |
| Displacement of time on cutin of defrost at start-up | | d05 | | | | 0 min | 240 min | 0 min | |
| Drip off time | | d06 | | | | 0 min | 60 min | 0 min | |
| Delay for fan start after defrost | | d07 | | | | 0 min | 60 min | 0 min | |
| Fan start temperature | | d08 | | | | -15°C | 0°C | -5°C | |
| Fan cutin during defrost | | d09 | | | | 0 | 2 | 1 | |
| 0: Stopped 1: Running 2: Running during pump down and defrost | | | | | | | | | |
| Defrost sensor (0=time, 1=S5, 2=Sair) | | d10 | | | | 0 | 2 | 0 | |
| Max. aggregate refrigeration time between two defrosts | | d18 | | | | 0 hours | 48 hours | 0 hours | |
| Defrost on demand - S5 temperature's permitted variation during frost build-up. On central plant choose 20 K (=off) | | d19 | | | | 0 K | 20 K | 20 K | |
| Fans | | | | | | | | | |
| Fan stop at cutout compressor | | F01 | | | | no | yes | no | |
| Delay of fan stop | | F02 | | | | 0 min | 30 min | 0 min | |
| Fan stop temperature (S5) | | F04 | | | | -50°C | 50°C | 50°C | |
| Real time clock | | | | | | | | | |
| Six start times for defrost. Setting of hours. 0=OFF | | t01-t06 | | | | 0 hours | 23 hours | 0 hours | |
| Six start times for defrost. Setting of minutes. 0=OFF | | t11-t16 | | | | 0 min | 59 min | 0 min | |
| Clock - Setting of hours | | t07 | | | | 0 hours | 23 hours | 0 hours | |
| Clock - Setting of minute | | t08 | | | | 0 min | 59 min | 0 min | |

| | | | | | | | | |
|--|-----|-----------------|--|---------------|-------|--------|-----|--|
| Clock - Setting of date | t45 | | | | 1 | 31 | 1 | |
| Clock - Setting of month | t46 | | | | 1 | 12 | 1 | |
| Clock - Setting of year | t47 | | | | 0 | 99 | 0 | |
| Miscellaneous | | | | | | | | |
| Delay of output signals after start-up | o01 | | | | 0 s | 600 s | 5 s | |
| Input signal on DI1. Function: 0=not used. 1=status on DI1. 2=door function with alarm when open. 3=door alarm when open. 4=defrost start (pulse-pressure). 5=ext.main switch. 6=night operation 7=change reference (activate r40). 8=alarm function when closed. 9=alarm function when open. 10=case cleaning (pulse pressure). 11=Inject off when open. | o02 | | | | 0 | 11 | 0 | |
| Network address | o03 | | | | 0 | 119 | 0 | |
| On/Off switch (Service Pin message) | o04 | | | | OFF | ON | OFF | |
| Access code 1 (all settings) | o05 | | | | 0 | 100 | 0 | |
| Used sensor type (Pt /PTC/NTC) | o06 | | | | Pt | ntc | Pt | |
| Display step = 0.5 (normal 0.1 at Pt sensor) | o15 | | | | no | yes | no | |
| Max hold time after coordinated defrost | o16 | | | | 0 min | 60 min | 20 | |
| Configuration of light function (relay 4) 1=ON during day operation. 2=ON / OFF via data communication. 3=ON follows the DI-function, when DI is selected to door function or to door alarm | o38 | | | | 1 | 3 | 1 | |
| Activation of light relay (only if o38=2) | o39 | | | | OFF | ON | OFF | |
| Case cleaning. 0=no case cleaning. 1=Fans only. 2=All output Off. | o46 | | | | 0 | 2 | 0 | |
| Access code 2 (partly access) | o64 | | | | 0 | 100 | 0 | |
| Save the controllers present settings to the programming key. Select your own number. | o65 | | | | 0 | 25 | 0 | |
| Load a set of settings from the programming key (previously saved via o65 function) | o66 | | | | 0 | 25 | 0 | |
| Replace the controllers factory settings with the present settings | o67 | | | | OFF | On | OFF | |
| Select application for S5 sensor (0=defrost sensor, 1= product sensor, 2=condenser sensor with alarm) | o70 | | | | 0 | 2 | 0 | |
| Select application for relay 4: 1=defrost/light, 2= alarm | o72 | defrost / Alarm | | Light / Alarm | 1 | 2 | 2 | |
| Service | | | | | | | | |
| Temperature measured with S5 sensor | u09 | | | | | | | |
| Status on DI1 input. on/1=closed | u10 | | | | | | | |
| Status on night operation (on or off) 1=closed | u13 | | | | | | | |
| Read the present regulation reference | u28 | | | | | | | |
| Status on relay for cooling (Can be controlled manually, but only when r12=-1) | u58 | | | | | | | |
| Status on relay for fans (Can be controlled manually, but only when r12=-1) | u59 | | | | | | | |
| Status on relay for defrost. (Can be controlled manually, but only when r12=-1) | u60 | | | | | | | |
| Temperature measured with Sair sensor | u69 | | | | | | | |
| Status on relay 4 (alarm, defrost, light).(Can be controlled manually, but only when r12=-1) | u71 | | | | | | | |

Factory setting

If you need to return to the factory-set values, it can be done in this way:

- Cut out the supply voltage to the controller
- Keep upper and lower button depressed at the same time as you reconnect the supply voltage

| Fault code display | | Alarm code display | | Status code display | |
|--------------------|------------------------------|--------------------|------------------------|---------------------|--|
| E1 | Fault in controller | A 1 | High temperature alarm | S0 | Regulating |
| E6 | Change battery + check clock | A 2 | Low temperature alarm | S1 | Waiting for end of the coordinated defrost |
| E 27 | S5 sensor error | A 4 | Door alarm | S2 | ON-time Compressor |
| E 29 | Sair sensor error | A 5 | Max. Hold time | S3 | OFF-time Compressor |
| | | A 15 | DI 1 alarm | S4 | Drip-off time |
| | | A 45 | Standby mode | S10 | Refrigeration stopped by main switch |
| | | A 59 | Case cleasning | S11 | Refrigeration stopped by thermostat |
| | | A 61 | Condenser alarm | S14 | Defrost sequence. Defrosting |
| | | | | S15 | Defrost sequence. Fan delay |
| | | | | S16 | Refrigeration stopped. (open DI input) |
| | | | | S17 | Door open (open DI input) |
| | | | | S20 | Emergency cooling |
| | | | | S25 | Manual control of outputs |
| | | | | S29 | Case cleaning |
| | | | | S32 | Delay of output at start-up |
| | | | | non | The defrost temperature cannot be displayed. There is stop based on time |
| | | | | -d- | Defrost in progress / First cooling after defrost |
| | | | | PS | Password required. Set password |

Los botones

Ajustar parámetros

1. Pulsar el botón superior hasta que aparece el parámetro r01.
2. Pulsar los botones alto y bajo hasta encontrar el parámetro deseadido.
3. Pulsar el botón central para ver el valor actual.
4. Pulsar los botones alto y bajo para modificar el valor.
5. Pulsar el botón central para confirmar el nuevo valor.

Ajustar la temperatura de corte

1. Pulsar el botón central para ver el valor actual.
2. Pulsar los botones alto y bajo para modificar el valor.
3. Pulsar el botón central para confirmar el nuevo valor.

Leer la temperatura de la sonda S5

- Pulsar y soltar el botón bajo

Iniciar/parar un desescarche manualmente

- Pulsar y mantener el botón bajo durante 4s.

LED's en el display

 = refrigeración

 = desescarche

 = ventiladores

Parpadean cuando hay una alarma

Rearmar el relé de alarma / ver el código de alarma

- Pulsar y soltar el botón alto

Puesta en marcha:

El equipo comienza a funcionar cuando se aplica alimentación eléctrica.

1 Revisar la programación por defecto (ver Menú de Parámetros) y ajustar los parámetros oportunos.

2 Si el equipo está conectado a un bus de comunicaciones, ajustar la dirección en o03 y enviar la dirección a la Gateway con o04.

SW = 1.3x

| Función | Parámetros | Código | Controlador | | | Valor - mín. | Valor - máx. | Ajuste fábrica | Ajuste actual |
|---|------------|---------|-------------|----------|----------|--------------|--------------|----------------|---------------|
| | | | EKC 202A | EKC 202B | EKC 202C | | | | |
| Funcionamiento normal | | | | | | | | | |
| Temperatura de corte (set point) | | --- | | | | -50°C | 50°C | 2°C | |
| Termostato | | | | | | | | | |
| Diferencial del termostato | | r01 | | | | 0,1 K | 20 K | 2 K | |
| Límite máximo al ajustar la temperatura de corte | | r02 | | | | -49°C | 50°C | 50°C | |
| Límite mínimo al ajustar la temperatura de corte | | r03 | | | | -50°C | 49°C | -50°C | |
| Corrección de la temperatura en el display | | r04 | | | | -20 K | 20 K | 0,0 K | |
| Unidades de temperatura (°C/°F) | | r05 | | | | °C | °F | °C | |
| Calibración de la sonda Saire | | r09 | | | | -10 K | 10 K | 0 K | |
| Marcha/paro interno: -1: modo manual, 0: EKC parado, 1: en marcha | | r12 | | | | -1 | 1 | 1 | |
| Desplazamiento de la temp. de corte durante la noche | | r13 | | | | -10 K | 10 K | 0 K | |
| Activar el incremento de la temperatura de corte | | r39 | | | | OFF | on | OFF | |
| Incremento de la temperatura de corte (grados) (activación por r39 o DI) | | r40 | | | | -50 K | 50 K | 0 K | |
| Alarma | | | | | | | | | |
| Retardo de alarma de temperatura (estándar) | | A03 | | | | 0 min | 240 min | 30 min | |
| Retardo de alarma de puerta | | A04 | | | | 0 min | 240 min | 60 min | |
| Retardo de alarma de temperatura (después de desescarche) | | A12 | | | | 0 min | 240 min | 90 min | |
| Límite de alarma por alta temperatura | | A13 | | | | -50°C | 50°C | 8°C | |
| Límite de alarma por baja temperatura | | A14 | | | | -50°C | 50°C | -30°C | |
| Retardo de la alarma asociada a DI | | A27 | | | | 0 min | 240 min | 30 min | |
| Límite de alarma por alta temperatura del condensador (con S5 y o70 = 2) | | A37 | | | | 0°C | 99°C | 50°C | |
| Compresor | | | | | | | | | |
| Mínimo tiempo de compresor en marcha (minutos) | | c01 | | | | 0 min | 30 min | 0 min | |
| Mínimo tiempo de entre dos arranques consecutivos (minutos) | | c02 | | | | 0 min | 30 min | 0 min | |
| Invertir el funcionamiento de la salida DO1 (compresor) | | c30 | | | | 0 / OFF | 1 / on | 0 / OFF | |
| Desescarche | | | | | | | | | |
| Tipo de desescarche (OFF/EL/gas) | | d01 | | | | no | gas | EL | |
| Temperatura fin de desescarche | | d02 | | | | 0°C | 25°C | 6°C | |
| Intervalo de tiempo entre desescarches | | d03 | | | | 0 horas | 48 horas | 8 horas | |
| Duración máxima del desescarche | | d04 | | | | 0 min | 180 min | 45 min | |
| Desplazamiento del 1º desescarche tras dar tensión al equipo | | d05 | | | | 0 min | 240 min | 0 min | |
| Tiempo de goteo | | d06 | | | | 0 min | 60 min | 0 min | |
| Retardo del ventilador tras el desescarche | | d07 | | | | 0 min | 60 min | 0 min | |
| Temperatura arranque del ventilador | | d08 | | | | -15°C | 0°C | -5°C | |
| Ventilador en marcha durante desescarche (no/yes) | | d09 | | | | 0 | 2 | 1 | |
| 0: parado | | | | | | | | | |
| 1: en marcha | | | | | | | | | |
| 2: en marcha durante el vaciado y el desescarche | | | | | | | | | |
| Sonda de fin de desescarche (0=no (tiempo), 1=S5, 2=Saire) | | d10 | | | | 0 | 2 | 0 | |
| Desescarche bajo demanda: tiempo acumulado refrigerando (0=Función cancelada) | | d18 | | | | 0 horas | 48 horas | 0 horas | |
| Desescarche bajo demanda: variación permitida a S5 (20 = Función cancelada) | | d19 | | | | 0 K | 20 K | 20 K | |
| Ventiladores | | | | | | | | | |
| Parar ventilador al parar compresor (yes/no) | | F01 | | | | no | yes | no | |
| Retardo de parada del ventilador | | F02 | | | | 0 min | 30 min | 0 min | |
| Temperatura de paro del ventilador (medida con S5) | | F04 | | | | -50°C | 50°C | 50°C | |
| Reloj de tiempo real | | | | | | | | | |
| Hasta seis horas (hh) de inicio de desescarche. 0=OFF | | t01-t06 | | | | 0 horas | 23 horas | 0 horas | |
| Los minutos (mm) de cada una de las 6 horas. 0=OFF | | t11-t16 | | | | 0 min | 59 min | 0 min | |
| Ajuste del reloj - hora | | t07 | | | | 0 horas | 23 horas | 0 horas | |
| Ajuste del reloj - minutos | | t08 | | | | 0 min | 59 min | 0 min | |

| | | | | | | | | |
|---|-----|------------------|--|--------------|-------|--------|-----|--|
| Ajuste del reloj - día | t45 | | | | 1 | 31 | 1 | |
| Ajuste del reloj - mes | t46 | | | | 1 | 12 | 1 | |
| Ajuste del reloj - año | t47 | | | | 0 | 99 | 0 | |
| Varios | | | | | | | | |
| Retardo de activación de salidas al dar tensión al equipo | o01 | | | | 0 s | 600 s | 5 s | |
| Función de la entrada digital DI1: 0=no utilizada. 1=comunica el estado de DI1. 2=puerta abierta y alarma. 3=sólo la alarma de puerta. 4=pulso para iniciar un desescarche. 5=interruptor principal. 6=operación nocturna 7=desplazamiento temperatura de corte (activación r40). 8=alarma al cerrar el contacto 9=alarma al abrir el contacto. 10=limpieza del mueble (pulso). 11= Inject off al abrir el contacto. | o02 | | | | 0 | 11 | 0 | |
| Dirección del EKC | o03 | | | | 0 | 240 | 0 | |
| Enviar la dirección del EKC a la gateway | o04 | | | | OFF | ON | OFF | |
| Código 1 de acceso a todos los parámetros (0= código desactivado) | o05 | | | | 0 | 100 | 0 | |
| Tipo de las sondas utilizadas (Pt /PTC/NTC) | o06 | | | | Pt | ntc | Pt | |
| Precisión del valor del display: yes = 0.5, no = 0,1 | o15 | | | | no | yes | no | |
| Máximo tiempo de espera tras un desescarche coordinado (sólo vía gateway) | o16 | | | | 0 min | 60 min | 20 | |
| Función de luz (relé 4; ver parámetro o72) 1=ON durante operación día. 2=ON / OFF vía bus de comunicaciones. 3=ON a la vez que la DI cuando esa DI es para la función de puerta o alarma de puerta. | o38 | | | | 1 | 3 | 1 | |
| Activación del relé de luz vía bus de comunicaciones (sólo si o38=2) | o39 | | | | OFF | ON | OFF | |
| Limpieza del mueble. 0=no activo. 1=Sólo ventilador en ON. 2= Todas las salidas en OFF. | o46 | | | | 0 | 2 | 0 | |
| Código 2 de acceso a parte de los parámetros (0=desactivar código) | o64 | | | | 0 | 100 | 0 | |
| Guardar la programación de un EKC en una "copy-key". | o65 | | | | 0 | 25 | 0 | |
| Volcar la programación desde una "copy-key" a un EKC | o66 | | | | 0 | 25 | 0 | |
| Sustituir los "ajustes de fábrica" por la programación actual | o67 | | | | OFF | On | OFF | |
| Función de la sonda S5: 0 = desescarche, 1 = producto, 2 = alarma temp. condensador | o70 | | | | 0 | 2 | 0 | |
| Función del relé 4: 1=desescarche (EKC 202A) o luz (EKC 202C), 2= alarma | o72 | Desesc. / Alarma | | Luz / Alarma | 1 | 2 | 2 | |
| Parámetros informativos (servicio). | | | | | | | | |
| Temperatura medida con la sonda S5 | u09 | | | | | | | |
| Estado de la entrada DI. (OFF = contacto abierto / ON = contacto cerrado) | u10 | | | | | | | |
| Estado de la operación nocturna (OFF = no activa / ON = activa) | u13 | | | | | | | |
| Temperatura de corte (set-point) | u28 | | | | | | | |
| Estado del relé de frío (0/off = desactivado, 1/on = activado)* | u58 | | | | | | | |
| Estado del relé del ventilador (0/off = desactivado, 1/on = activado)* | u59 | | | | | | | |
| Estado del relé de desescarche (0/off = desactivado, 1/on = activado)* | u60 | | | | | | | |
| Temperatura medida con la sonda Saire | u69 | | | | | | | |
| Estado del relé 4 (0/off = desactivado, 1/on = activado)* | u71 | | | | | | | |

*) Pueden operarse manualmente si r12= -1

Ajustes de fábrica

Si se necesita volver a la programación de fábrica, se procederá así:

- Se corta la alimentación eléctrica al EKC
- Se restablece la alimentación eléctrica mientras se mantienen pulsados los botones alto y bajo durante unos segundos.

| Código de fallos | | Códigos de alarma | | Códigos de estado | |
|------------------|---|-------------------|--|-------------------|--|
| E1 | Fallo del controlador | A 1 | Alarma por alta temperatura de aire | S0 | Enfriando |
| E6 | Fallo reloj (comprobar pila y "resetear" reloj) | A 2 | Alarma por baja temperatura de aire | S1 | Esperando final de desescarche coordinado. |
| E 27 | Error en la sonda S5 | A 4 | Alarma de puerta | S2 | Compresor dentro del mín. tiempo en marcha. |
| E 29 | Error en la sonda Saire | A 5 | Expirada la espera tras desescarche coordinado | S3 | Compresor mín. tiempo entre arranques consecutivos. |
| | | A 15 | Alarma asociada a DI | S4 | Tiempo de goteo en curso. |
| | | A 45 | EKC parado (ya sea por r12 ó por la DI) | S10 | Equipo parado (desde r12 ó desde DI) |
| | | A 59 | Limpieza del mueble | S11 | Refrigeración parada. (Se ha alcanzado la temperatura de corte). |
| | | A 61 | Alarma de temperatura del condensador | S14 | Desescarchando |
| | | | | S15 | Retraso del ventilador tras desescarche. |
| | | | | S16 | Refrigeración parada. (entrada DI abierta) |
| | | | | S17 | Puerta abierta |
| | | | | S20 | Refrigeración en emergencia. |
| | | | | S25 | Control manual, forzado, activo. |
| | | | | S29 | Limpieza del mueble |
| | | | | S32 | Retraso inicial al dar tensión al equipo. |
| | | | | non | No se puede mostrar la temperatura de desescarche. No hay sonda. |
| | | | | -d- | Se está realizando un desescarche. |
| | | | | PS | PS: introduzca contraseña (Código de acceso) |

