

Compresseur / Compressor
Code tension / Voltage code : F



CAJ2432Z

Froid commercial négatif (BP)
Low back pressure commercial application

220-240V / 50Hz - 1~

R404A



N° 124ET-F - ind f

Conditions <i>Conditions</i>	fréquence <i>frequency</i>	Prod frigorifique nominale / <i>nominal refrigerating capacity</i>			Puis. sonore <i>Sound level</i>
		Watts	Kcal/h	BTU/h	
EN 12900*	50 Hz	381	328	1299	ISO 3745 / ISO 3743-1
Cecomaf	50 Hz	507			58 dBA

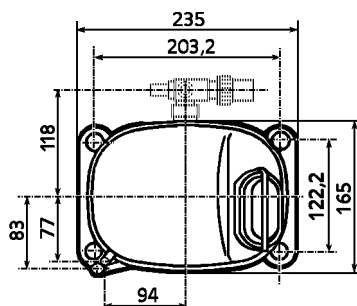
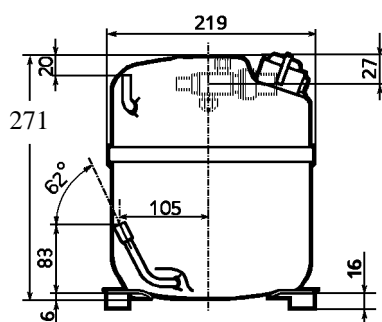

Cylindrée / *Displacement*: 18.3 cm³
Poids net / *Net weight*: 20.8 Kg
Charge en huile / *Oil charge*: 887 cm³
Type d'huile / *Oil type*: P.O.E /
Détente / *Expansion device*: Capillaire/Détendeur
Capillary/Exp° valve
Refroidissement / *Cooling*: Ventilé / *Forced*

Résistance à 20° C / *Windings resistances at 20° C*
Phase princ. / *Main Winding*: 4.5 Ohms
aux. / *Auxiliary Winding*: 9.8 Ohms

Intensité / *Current*
nom. / *Rated current RLA*: 2.4 A
max. / *Max current*: 5.9 A
dém. / *Start current LRA*: 21 A

Ap. Electrique / *Electrical equipment*: CSR

Protecteur / *Overload*: MRA38111
Temporisation / *Time check*: 7.5s - 14s / 15.4 A
T° ouverture / *Opening temp.*: 105° C
fermeture / *Closing temp.*: 52° C
Option / *optional*: T0348

Relais potentiel / *Potential relay*: RVA4P**
enclenchement / *Pick up*: 300/320V
déclenchement / *Drop out*: 60/121V
Option / *optional*: 3ARR3*10AD*

Condensateur dém. / *Start capacitor*: 88 µF / 330 V
Condensateur Perm. / *Run capacitor*: 15 µF / 400 V

* EN12900: T°cond.+40°C / T°évap.-35°C / T°gas aspirés. +20°C /
Sous refroidissement. OK
* EN 12900 : Cond. T° +40°C / Evap. T° -35°C / Return gas T° +20°C /
Subcooling. OK

Pour conduites Ø ext / *For tubing O.D.*

Aspiration <i>Suction</i>	Refoulement <i>Discharge</i>	Charge <i>Process</i>
12.7 (1/2")	7.9 (5/16")	6.35 (1/4")

Les caractéristiques données dans cette fiche technique peuvent évoluer sans avis préalable, avec les améliorations que 'TECUMSEH EUROPE' entend toujours apporter à sa production.
'TECUMSEH EUROPE', in a constant endeavour to improve its products reserves the right to change any information contained in this leaflet without prior warning.



L'UNITE
HERMETIQUE



Tecumseh

CAJ2432Z	Tension F : 220 - 240V 1~ 50 Hz	R404A	N°124ET-F	Ind f
-----------------	---------------------------------	-------	-----------	-------

Les performances sont données dans les conditions EN 12900 : Elles sont certifiées uniquement en 50 Hz	Gaz aspirés : 20°C Sous refroidissement : 0°K
The performance data are in EN 12900 conditions : They are only certified in 50 Hz	Return gas : 20°C Subcooling : 0°K

50 Hz R404A									
4 T condensation	5 T évaporation	(°C)	-40	-35	-30	-25	-20	-15	-10
30	1 P frigorifique	(W)	342	496	687	917	1192	1514	1887
	2 P absorbée	(W)	360	418	476	536	597	661	729
	3 I absorbée	(A)	1.63	1.87	2.13	2.4	2.69	3	3.32
40	1 P frigorifique	(W)	249	381	542	738	971	1247	1567
	2 P absorbée	(W)	347	417	487	560	636	716	801
	3 I absorbée	(A)	1.58	1.87	2.18	2.51	2.85	3.21	3.58
50	1 P frigorifique	(W)		266	398	557	749	976	1243
	2 P absorbée	(W)		396	478	563	653	748	850
	3 I absorbée	(A)		1.8	2.16	2.54	2.93	3.34	3.77
60	1 P frigorifique	(W)			259	382	530	708	919
	2 P absorbée	(W)			450	548	651	760	877
	3 I absorbée	(A)			2.07	2.5	2.94	3.4	3.88
1 = refrigerating capacity 2 = watt input 3 = current 4 = condensing temperature 5 = evaporating temperature									

Nota : Les caractéristiques données dans cette fiche technique peuvent évoluer sans avis préalable, avec les améliorations que "TECUMSEH EUROPE" entend toujours apporter à sa production.

Note : "TECUMSEH EUROPE", in a constant endeavour to improve its products reserves the right to change any information contained in this leaflet without prior warning.